

Technische fiche :

MRT 1845 75

VISION





MRT 1845 75 Gemaakt op 3 oktober 2022 om 11:38:38 UTC

Capacities		Metrisch
Max. capacity		4500 kg
Max. lifting height		18 m
Max. outreach		15.20 m
Weight and dimensions		
Overall width	b1	2.42 m
Overall height	h17	3.04 m
Overall cab width	b4	0.96 m
Ground clearance	m4	0.37 m
Wheelbase	y	2.43 m
Tilt-up angle	a4	10 °
Tilt-down angle	a5	107 °
Turret rotation / rotation (Max.)		400 ° or 360 °
Overall weight		14100 kg
Forks length / width / section	l / e / s	1200 mm x 125 mm x 50 mm
Wheels		
Standard tyres		405/70-20
Drive wheels (front / rear)		2 / 2
Steering mode		2 wheel steer, 4 wheel steer, Crab mode
Stabilisers		
Stabs Type		Wing Type
Controls with stabs		Stabs Commands Individual or Simultaneous
Engine		
Engine brand		Deutz
Engine norm		Stage V / Tier 4
Engine model		TCD 3.6 L4
I.C. Engine power rating / Power (kW)		55.92 kW / 55.40 kW
Max. torque / Engine rotation (min)		405 Nm @ 1300 rpm
Number of cylinders - Capacity of cylinders		4 - 3620 cm³
Engine cooling system		Water cooled
Number of batteries / Battery / Batteries capacity		2 x 12 V / 120 Ah
Battery starting current		(EN)850 A
Transmission		
Transmission type		Hydrostatic
Number of gears (forward / reverse)		2 / 2
Max. travel speed		25 km/h
Drawbar pull (Laden)		9400 daN
Parking brake		Automatic negative parking brake
Service brake		Oil-immersed multi-discs braking on front & rear axles
Performances		
Gradeability (laden / unladen)		44.50 % / 44.50 %
Hydraulics		
Hydraulic pump type		Variable displacement pump
Hydraulic flow		116 l/min
Hydraulic Pressure		275 bar
Tank capacities		
Engine oil		11 l
Hydraulic oil		144 l
Fuel tank		130 l
Noise and vibration		
Noise at driving position (LpA)		68 dB
Environmental noise (LwA)		106 dB
Vibration to whole hand/arm		< 2.50 m/s²
Miscellaneous		
Steering wheels (front / rear)		2 / 2
Controls		2 Joysticks
Safety cab homologation		Cabin ROPS - FOPS Level 2
Attachment recognition system (E-Reco)		Standard

MRT 1845 75 - Tekening met afmetingen

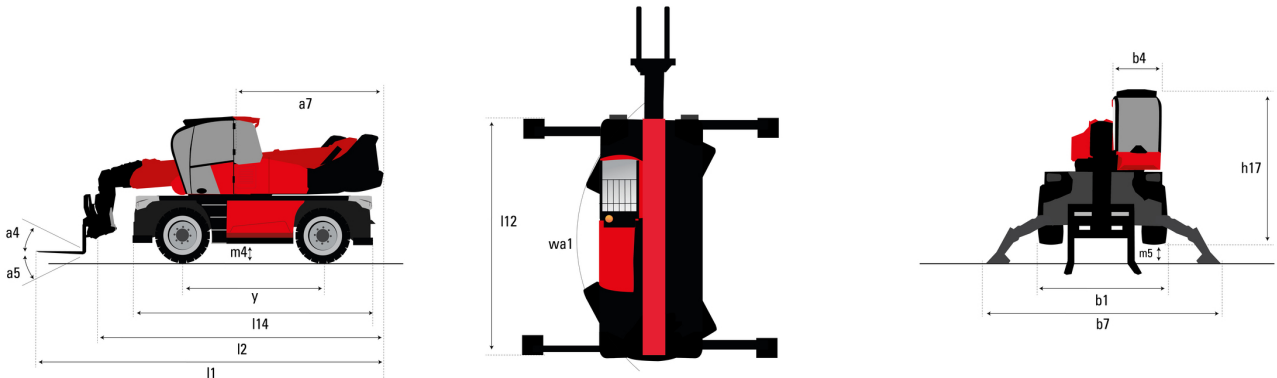

Andere gegevens		Metrisch
Overall length (with forks)	l1	7.26 m
Length to face of forks	l2	6.06 m
Length of frame	l14	4.67 m
Wheelbase	y	2.43 m
Ground clearance	m4	0.37 m
Counterweight offset (turret at 90°)	a7	2.50 m
Tilt-up angle	a4	10 °
Tilt-down angle	a5	107 °
Overall length at stabilisers	l12	4.41 m
External turning radius (over tyres)	Wa1	3.92 m
Overall width	b1	2.42 m
Overall width with stabilisers extended	b7	4.01 m
Overall cab width	b4	0.96 m
Overall height	h17	3.04 m
Ground clearance under front tires on stabilizers	m5	0.18 m

MRT 1845 75 - Lastendiagram

Machine on tyres with forks Metric

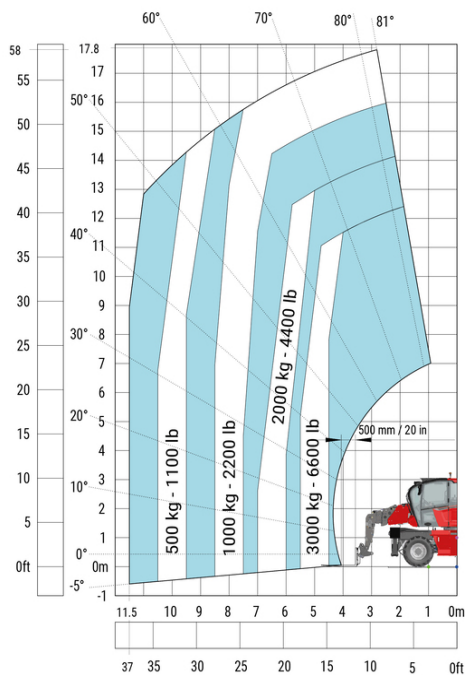

Machine on lowered stabilisers with forks Metric

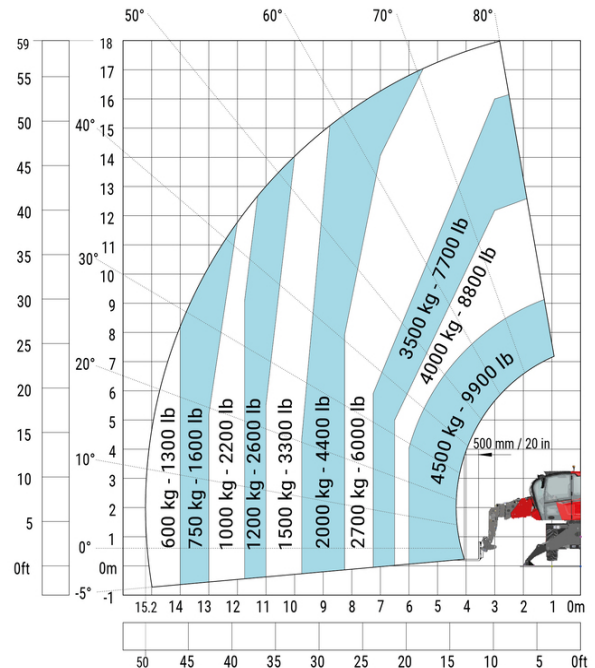

Machine on lowered stabilisers with jib 4000 kg (Metric)

Machine on lowered stabilisers with 365 kg platform Metric

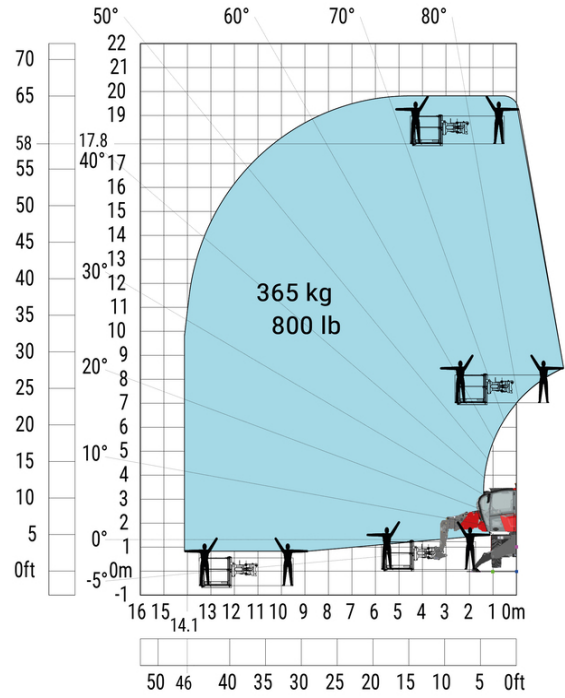
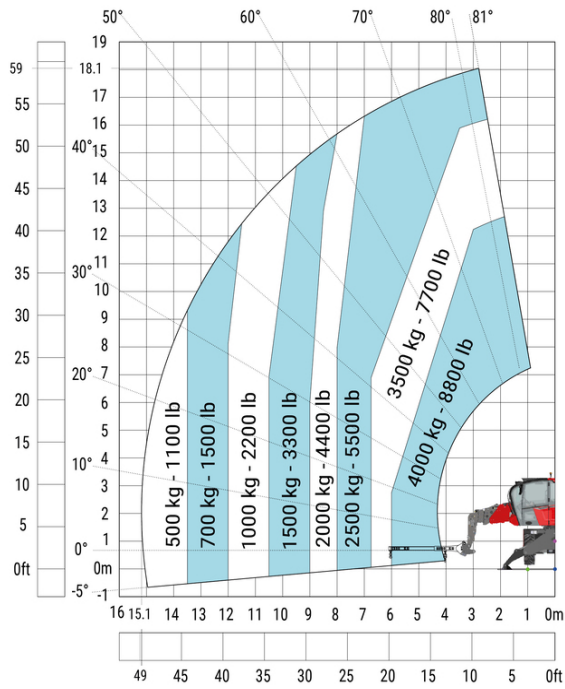

Machine on lowered stabilisers with 1000 kg platform Metric

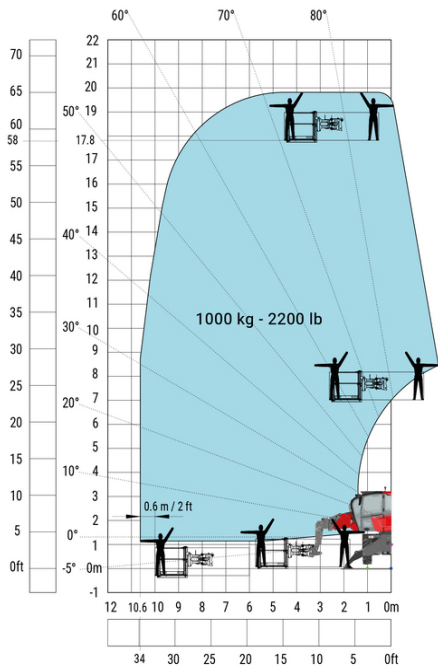

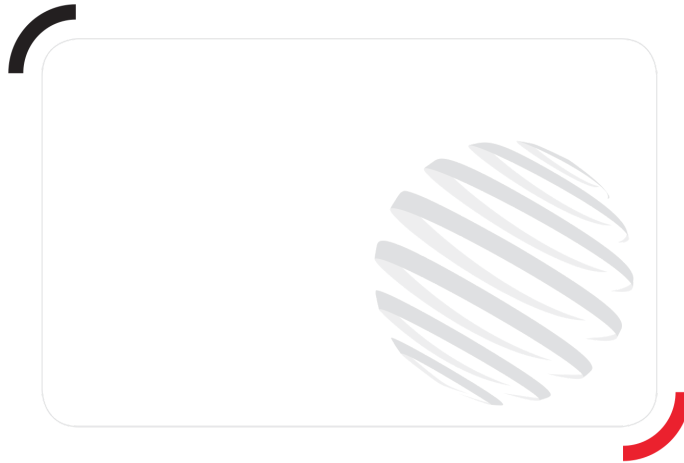

MANITOU

HANDLING YOUR WORLD

Hoofdkantoor

B.P. 249 - 430 rue de l'Aubinière
44150 Ancenis Cedex - Frankrijk

Tel.: 00 33 (0)2 40 09 10 11 - Fax: 00 33 (0)2 40 09 10 97

www.manitou.com



Deze brochure beschrijft versies en configuratie-opties voor Manitou-producten die met verschillende apparatuur kunnen worden uitgerust. De uitrusting die in deze brochure wordt beschreven, kan standaard, optioneel of niet leverbaar zijn, afhankelijk van de uitvoering. Manitou behoudt zich het recht voor om de weergegeven en beschreven specificaties op elk moment en zonder kennisgeving vooraf te wijzigen. De fabrikant is niet aansprakelijk voor de gegeven specificaties. Neem voor meer informatie contact op met uw Manitou-dealer. Niet-contractueel document. De productbeschrijvingen kunnen afwijken van de werkelijke producten. De lijst met specificaties is niet allesomvattend. De logo's en visuele identiteit van het bedrijf zijn eigendom van Manitou en mogen niet zonder toestemming worden gebruikt. Alle rechten voorbehouden. De foto's en diagrammen in deze brochure zijn uitsluitend bedoeld voor raadpleging en informatie.

MANITOU BF SA - Naamloze vennootschap met raad van bestuur - Aandeelkapitaal: 39.668.399 euro - 857 802 508 RCS Nantes